

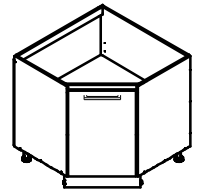

NOVA PLUS NOPL-065-RS



V PRÍPADE REKLAMÁCIE JE POTREBNÉ NAHLÁSIŤ
 VÝROBNÉ ČÍSLO VIDITEĽNÉ NA ETIKETE







22300,00 	27000,00 	21102,00 	35101,01 	32021,00 		36033,01 	22243,00 	22060,00 	60025,05
A 15x	B 6x	C 30x	D 6x	E 1x	F 10x	G 2x	H 4x	J 4x	K 4x

50552,00 	36032,00 	22244,01 	22224,01 	22601,00
L 2x	M 2x	N 10x	P 24x	Q 4x

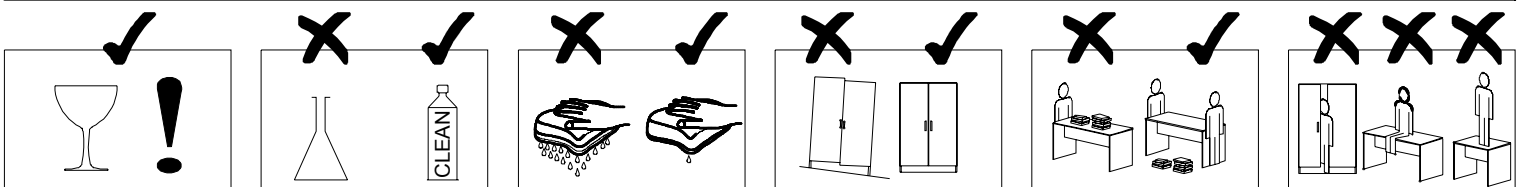
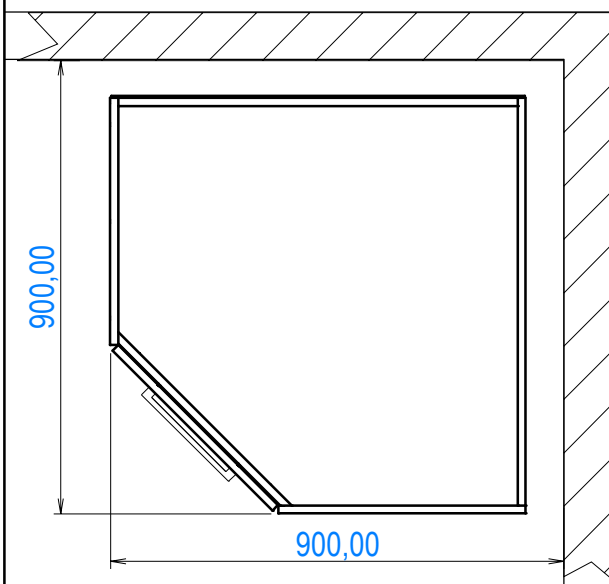
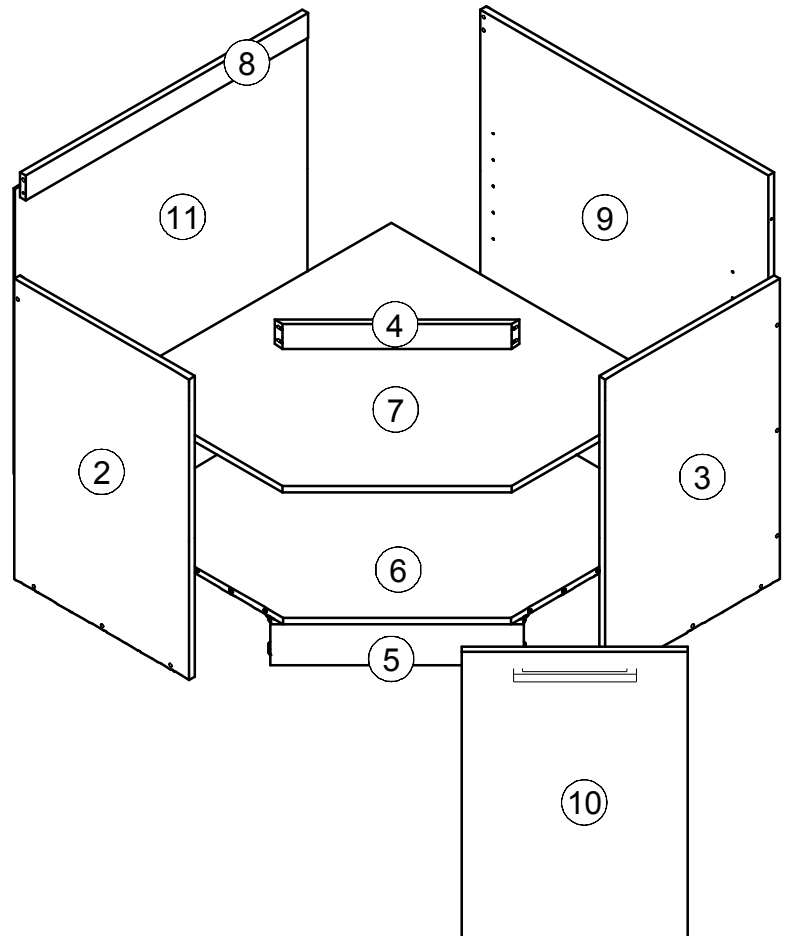

 0h 55min			 3m	 4	 PZ 2	 ≤ 0,5 kg
--------------	--	--	--------	-------	----------	--------------

ID	ID	Image	Dimensions	Quantity	Ratio
04576	2		730*490*16	1x	1/1
04577	3		730*490*16	1x	1/1
04578	4		486*60*16	1x	1/1
04579	5		510*100*16	1x	1/1
04580	6		808*808*16	1x	1/1
04581	7		808*792*16	1x	1/1
04582	8		792*60*16	1x	1/1
04583	9		713*808*16	1x	1/1
04584	10		448*694*16	1x	1/1
04585	11		694*-820*2,5	1x	1/1



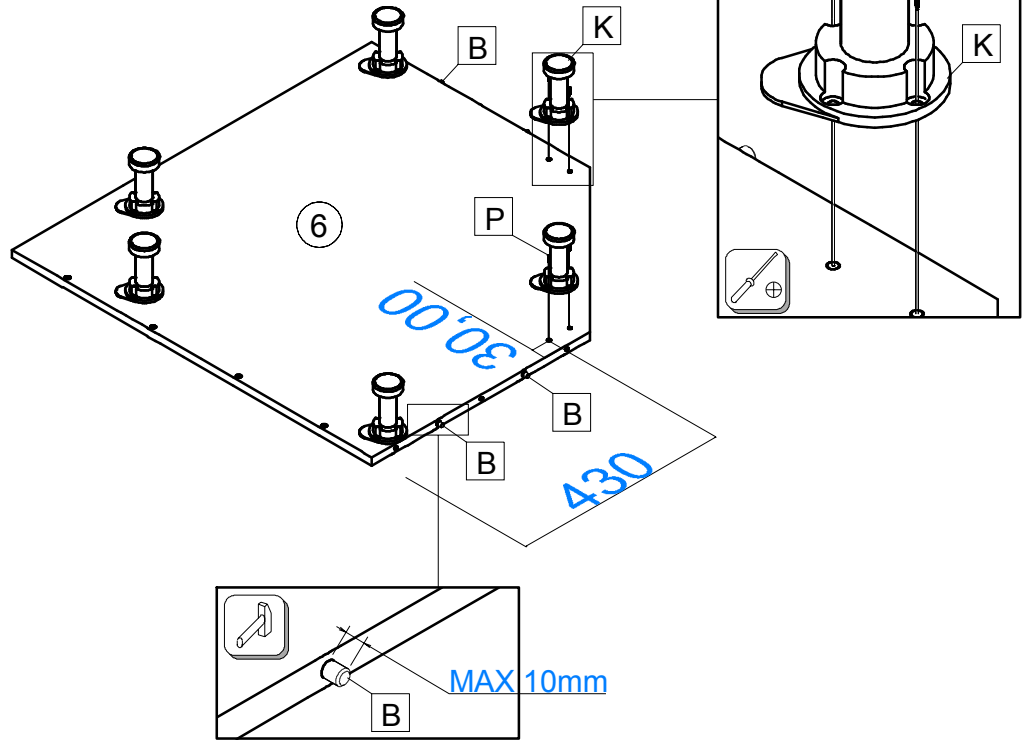

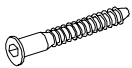

		
K 6x	Ø4x16 P 24x	Ø8x30 B 4x

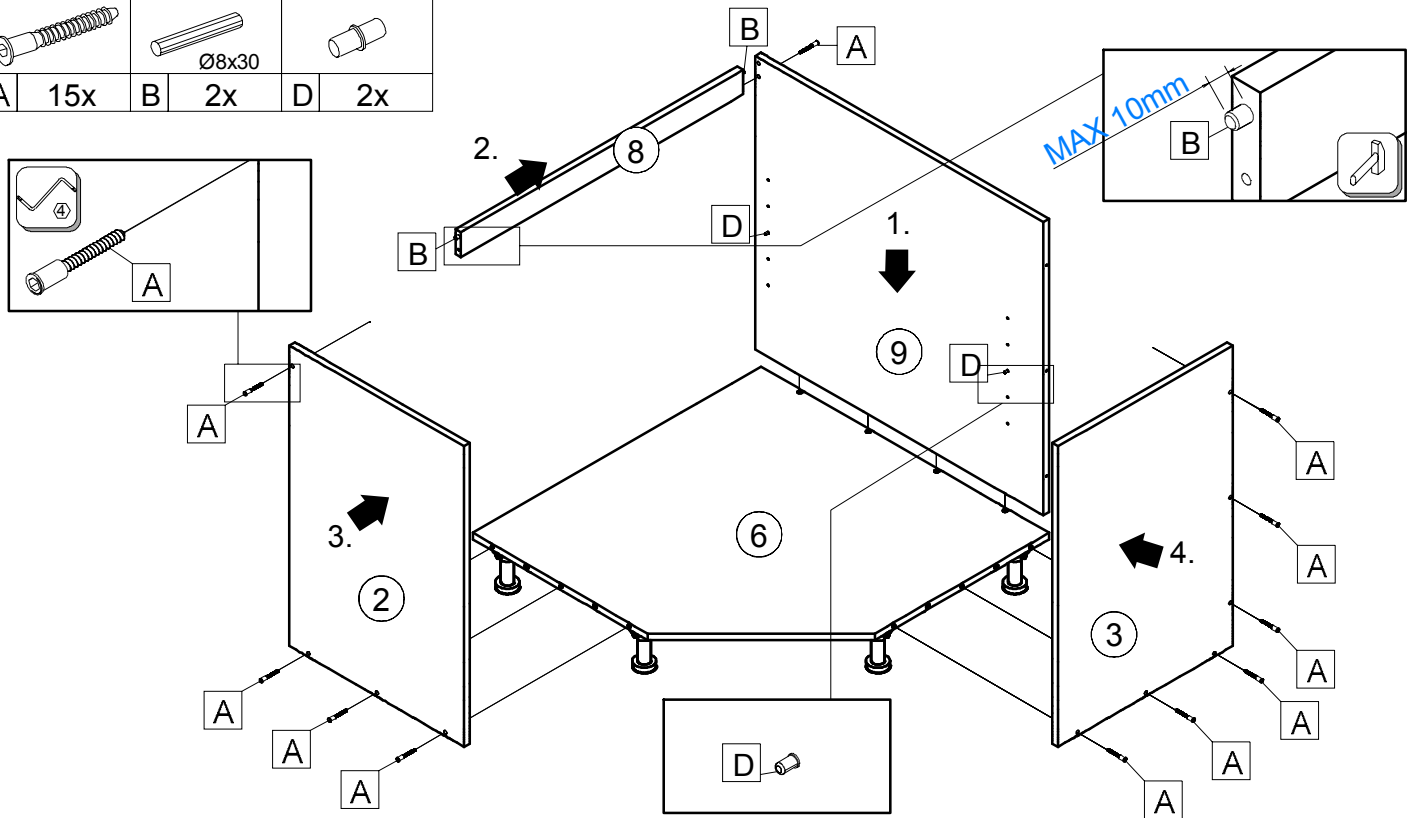

		
A 15x	Ø8x30 B 2x	D 2x



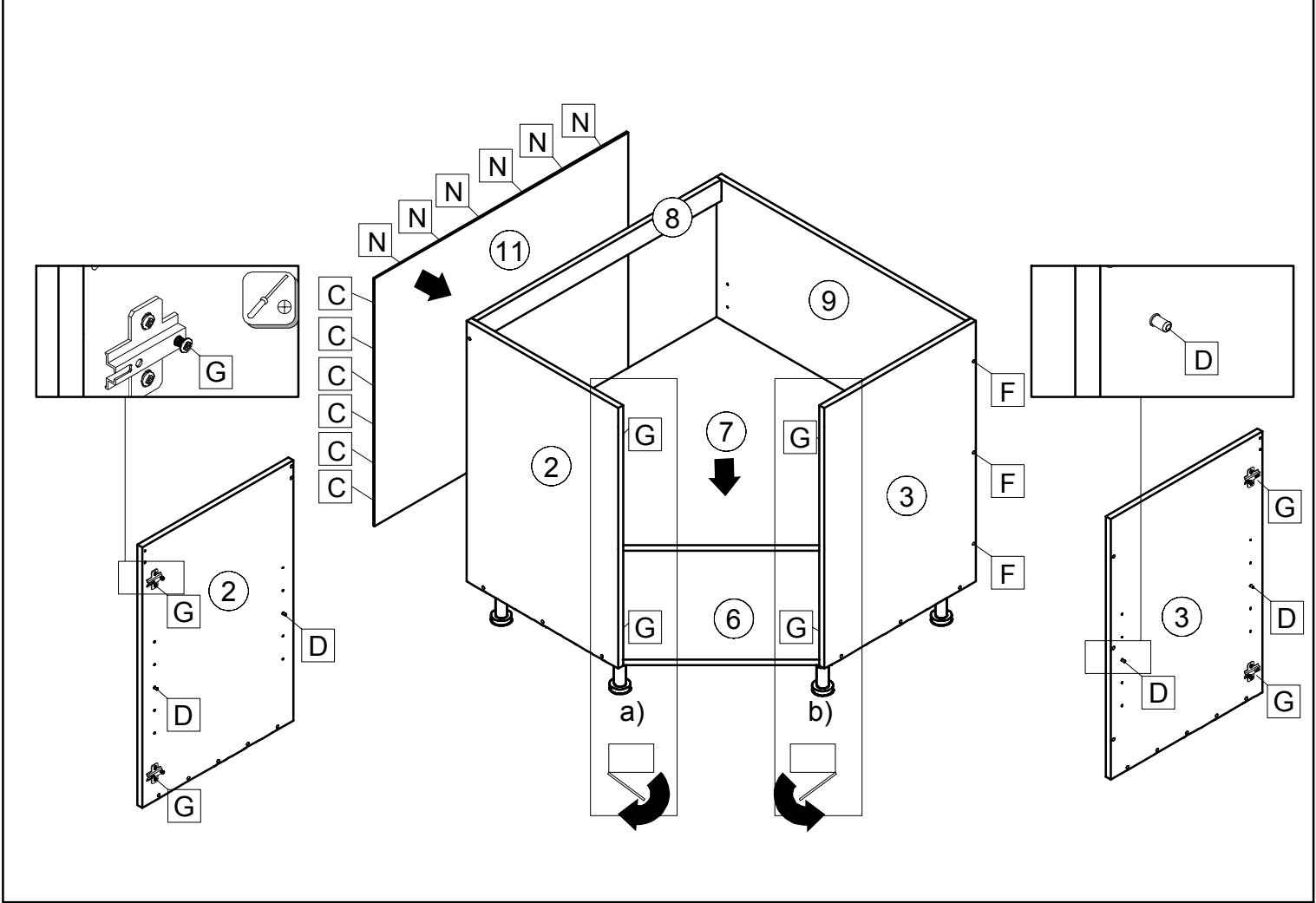

				
Ø1,6x20		Ø3,5x16		
C 30x	D 4x	N 6x	F 10x	G 2x



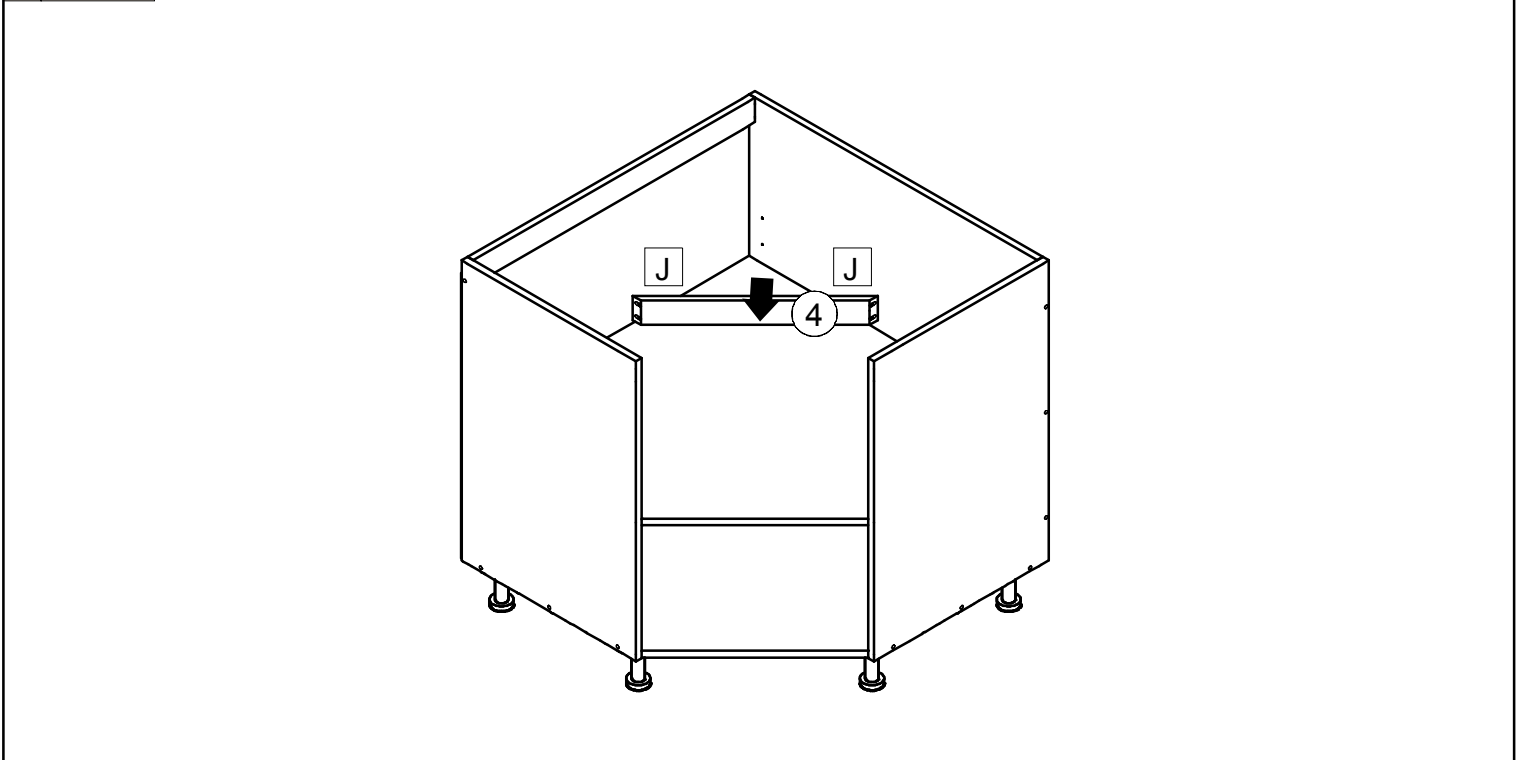

	Ø4x30
J 4x	

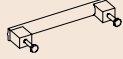

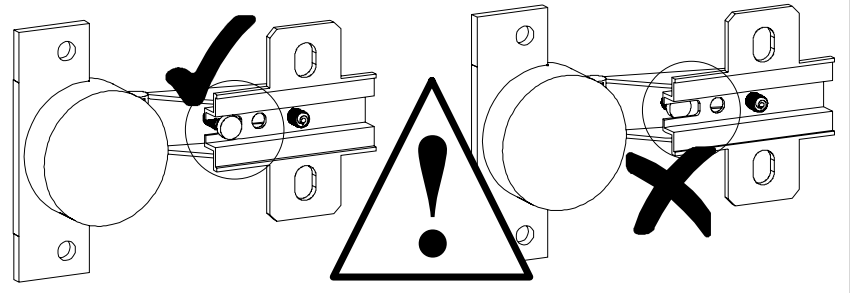
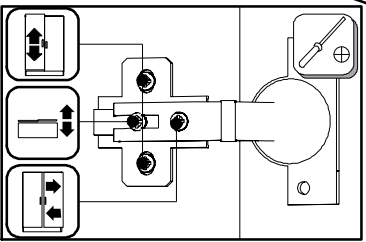
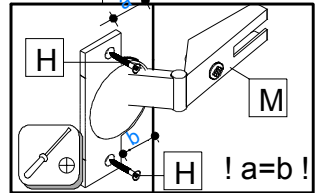
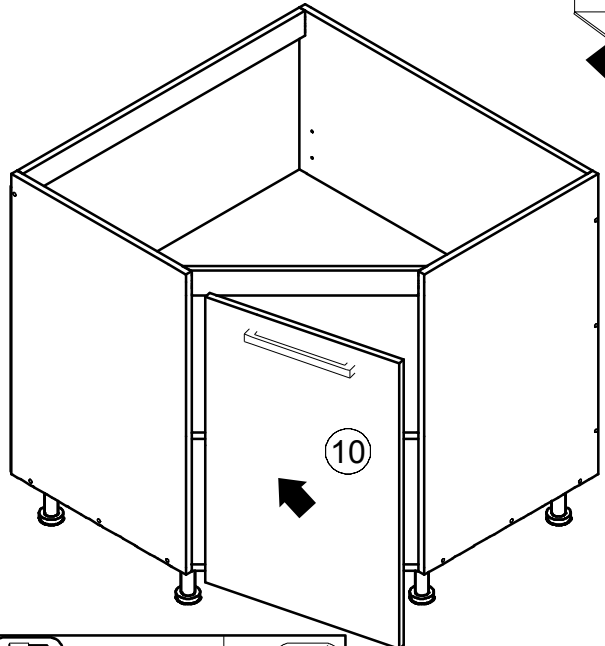
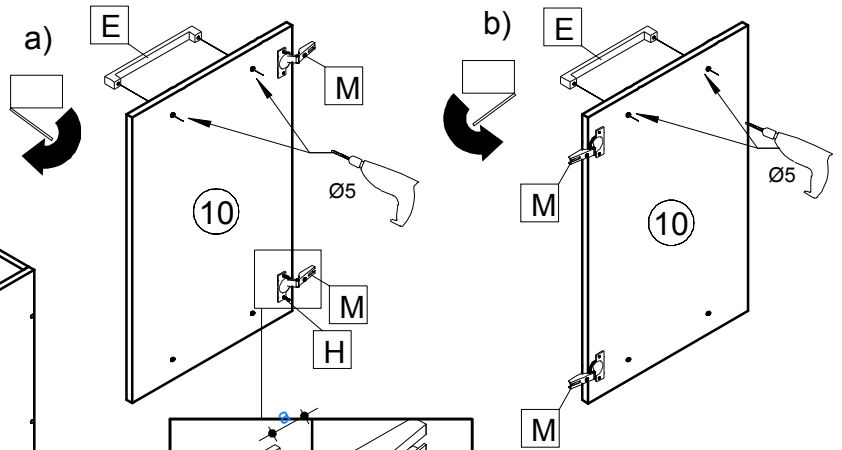
		
M 2x	Ø3,5x15 4x	E 1x



	
L 2x	N 4x

